

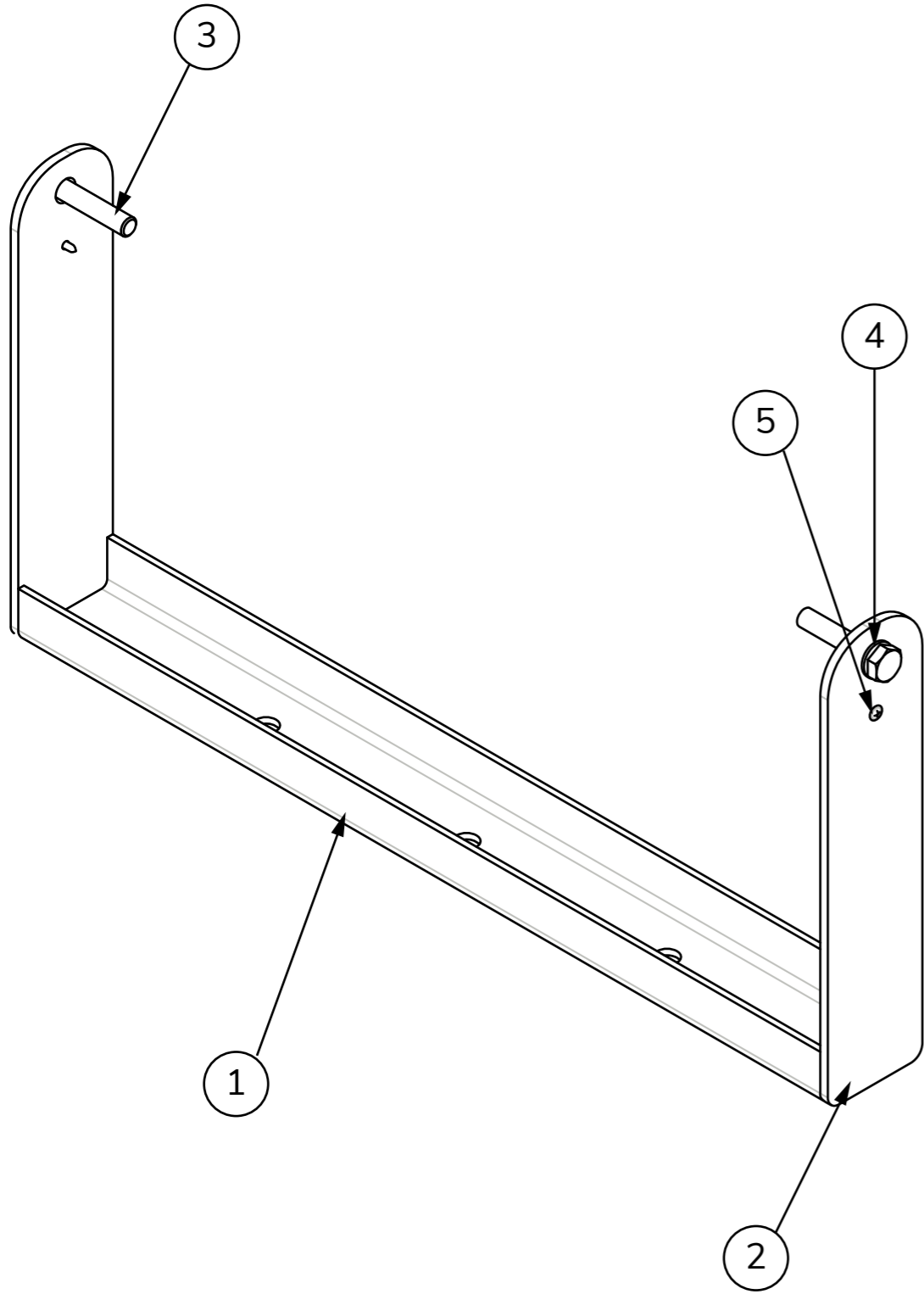

U Bracket4

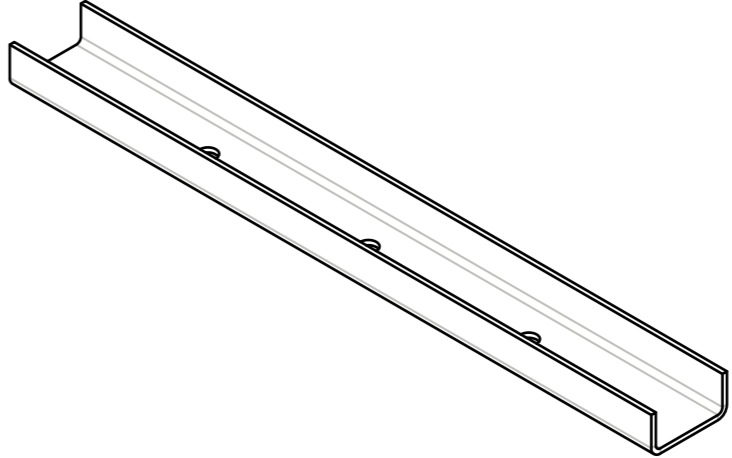

ITEM NO.	DESCRIPTION	Qty.
1	U4 U Chanel 	1
2	U4 End Plate 	2
3	BS EN 24014 - M8 x 40 x 22-N 	2
4	Rectangular section spring washer BS 4464 - 8 (Type B) 	2
5	NO4 X 10 FLANGE 	2

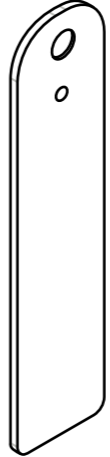
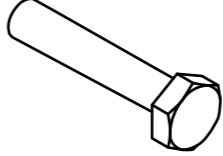

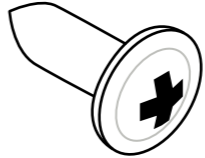
Optimal Audio

OPTIMAL AUDIO GROUP LTD
 CENTURY POINT, HALIFAX ROAD
 CRESSEX BUSINESS PARK,
 HIGH WYCOMBE,
 BUCKINGHAMSHIRE
 HP12 3SL, ENGLAND
 TEL: +44 (0)1494 535312
 WEB: www.optimal-audio.co.uk

DATE:

19/01/2022

DRAWN BY:

CC

ISSUE:

001

All information is Copyright ©
 by Optimal Audio Group Ltd.

U Bracket4